

Article number: 03552030

Description: Fluro hydraulic rod end FPR 30N

Measures

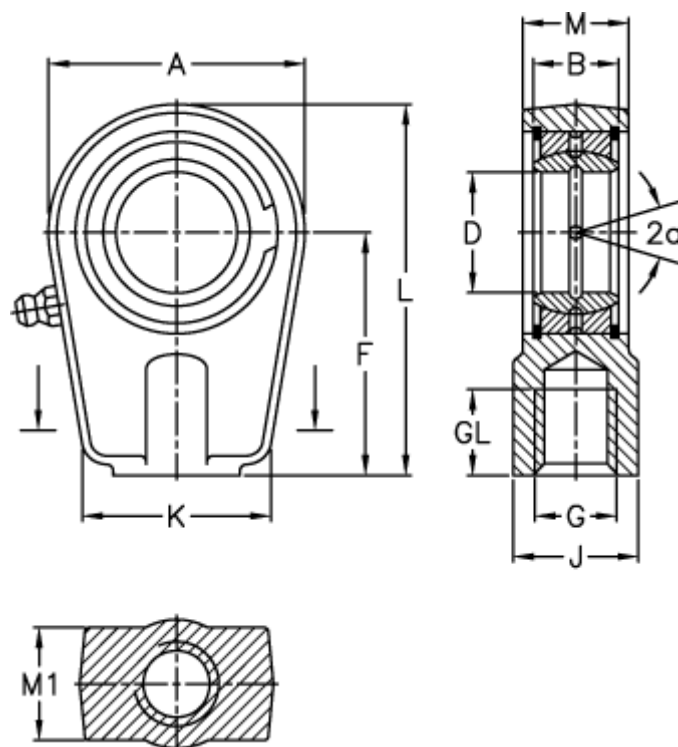

A	= 64	J	= 32
a (degrees)	= 6	K	= 50
B	= 22	L	= 94
D	= 30	M	= 28
Dynamic load C (kN)	= 62	M1	= 26
F	= 60	Static load C0 (kN)	= 106
g	= M22x1,5	Weight	= 700
GL	= 23		